



CUSTOMISED GLAZING WINDOWS AND DOORS



jimmy@jrfixing.ie



www.jrfixing.ie



0879681592

Table of Contents



03
Windows

10
Doors

41
Handles

50
Lift & Slide

53
Gallery





UPVC Windows and Doors

Energy-efficient windows



High Energy Saving and Acoustic Insulation

Our Windows is designed to guarantee high energy savings and acoustic insulation. With frame depth 76mm achieves the same technical properties as wider passive profiles.

High thermally efficient uPVC windows

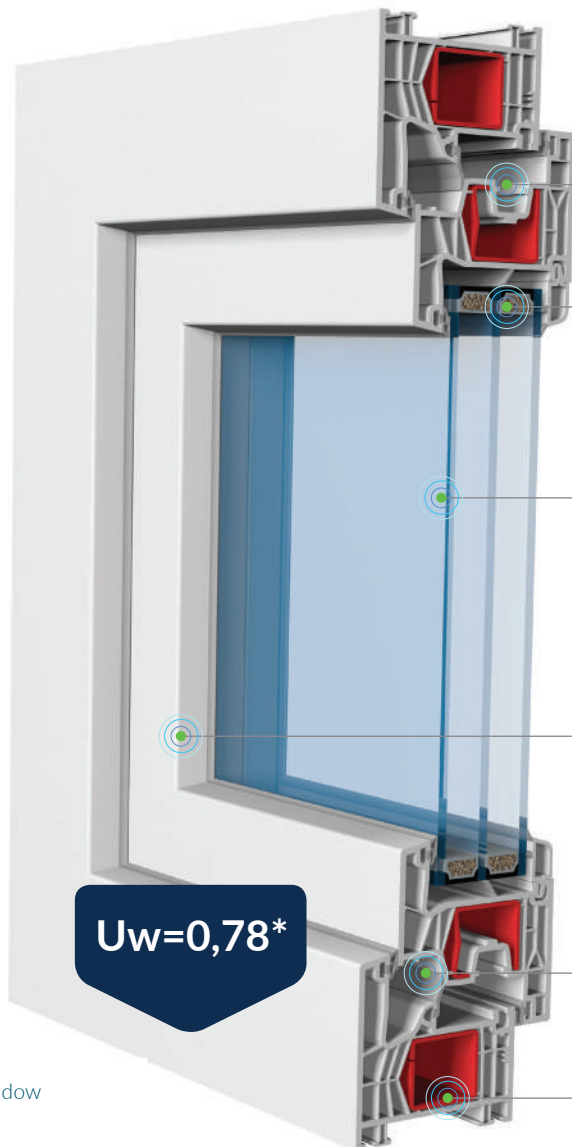

window

Fittings

Siegenia multi-point locking fittings, wide adjustment range, unquestioned reliability

Warm edge spacer

Increased thermal insulation, reduction of thermal bridges

Glazing

Triple-glazed units 4/18/4/18/4, $U_g = 0,5 \text{ W/m}^2\text{K}$, Low-E glass with good sound-proof performance

Profile

6-chamber Kommerling profile, German made, frame width 76 mm

Three-seal system

MD system with central seal improving protection against rain, wind and heat transfer

Steel reinforcement

Sections of galvanized steel guaranteeing high static parameters of window construction

* Heat transfer coefficient for reference window [1230x1480, $U_g=0,5 \text{ W/m}^2\text{K}$ with warm edge spacer Chromatech Ultra]

Windows

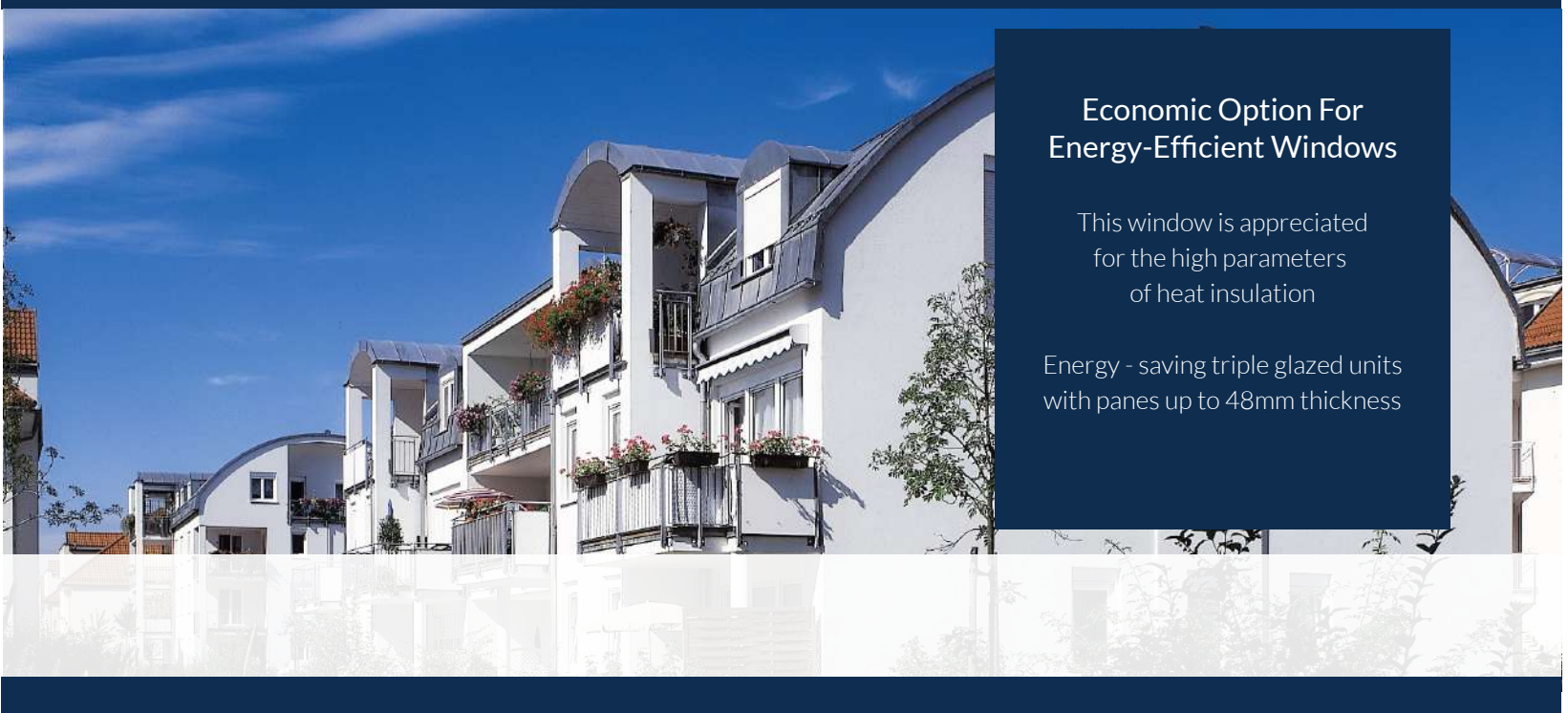

Economic Option For Energy-Efficient Windows

This window is appreciated for the high parameters of heat insulation

Energy - saving triple glazed units with panes up to 48mm thickness



window

Fittings

Siegenia multi-point locking fittings, wide adjustment range, unquestioned reliability

Glazing

triple-glazed unit
4/18/4/18/4
 $U_g = 0,5 \text{ W/m}^2\text{K}$,
Low-E glass

Profil

5-chamber K mmerling profile, German made, frame width 76 mm

Steel reinforcement

Sections of galvanized steel guaranteeing high static parameters of window construction.

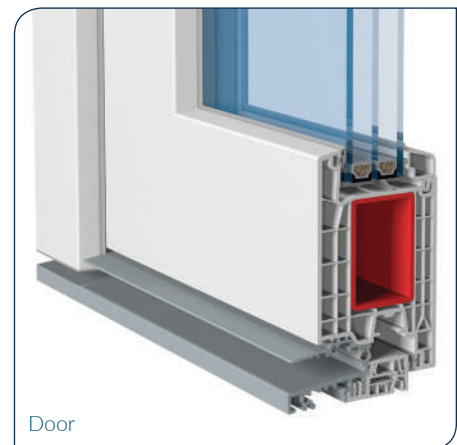

Door

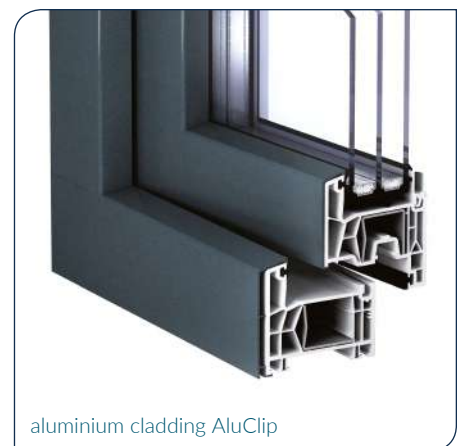

aluminium cladding AluClip

Premidoor 76



Premidoor 76 – elegance & functionality



Profile

5-chamber uPVC profile characterised by increased strength parameters

Glazing

Triple-glazed unit 4/18/4/18/4,
U_g = 0,5 W/m²K,
Low-E glass with good soundproofing parameters

Hardware

Siegenia AUBI-HS Portal

U_w = 0,9*

Premidoor 76
Lift and Slide door HST

Premidoor 76

HS Door is attractive and practical alternative for traditional balcony doors. Our doors are constructed with a thought about clients for who care about: sunlight exposure, flexibility of interior design, sense of the space and unique design

PREMIDOOR 76

Facility in space design

Max dimensions in this system are:
height: 2,6 m and width 6,5 m

Sliding door gives building light appearance and ensures the proper lighting of rooms

Special system of rails allows to open and close the door with the use of minimal force



* Heat transfer coefficient for reference HS door [3500mmx2500mm], U_g=0,5 W/m²K with warm Edge spacer Chromatech Ultra

Premidoor 76 LUX



Premidoor 76 LUX - more light



Profil

5-chamber uPVC profile characterised by increased strength parameters

Glazing

Triple-glazed unit 4/18/4/18/4, $U_g = 0,5 \text{ W/m}^2\text{K}$, Low-E glass with good soundproofing parameters

Profil LUX

Width of profile in fixed sash is only 40 mm

Premidoor 76 LUX
Lift & Slide door HST

Premidoor 76 LUX

Profile with reduced height has been used in fixed sash.

Glazing area is larger than in standard constructions, this solution provides more sunlight and enlarges the room.

PREMIDOOR 76 LUX

Large glazing

Improved Premidoor 76 where fixed sash is characterized by larger area of glazing than in standard constructions

Construction with thinner profile provides more sunlight in room
Possible surface options: Renolit foil, wide range of RAL colours, aluminum cladding

Modern design





uPVC painted windows

When designing the facades of the buildings as well as the interior arrangements, windows are becoming increasingly important. Modern building industry requires perfect colour matching of the walls, roofs and windows joinery. The use of painting technology of uPVC windows creates a wide array of colour options. The range of colours from the RAL colour chart opens up unlimited possibilities for building design and also creates modern, unique architectural designs.

In the colour coating process we use paints from the renowned Swiss company FEYCO. Feyco is the first company in Europe which has prepared and implemented advanced painting technology for uPVC profiles.



Our painted uPVC windows are distinguished by their high resistance to atmospheric, chemical, and mechanical factors. uPVC painted windows become extremely popular across the European market.



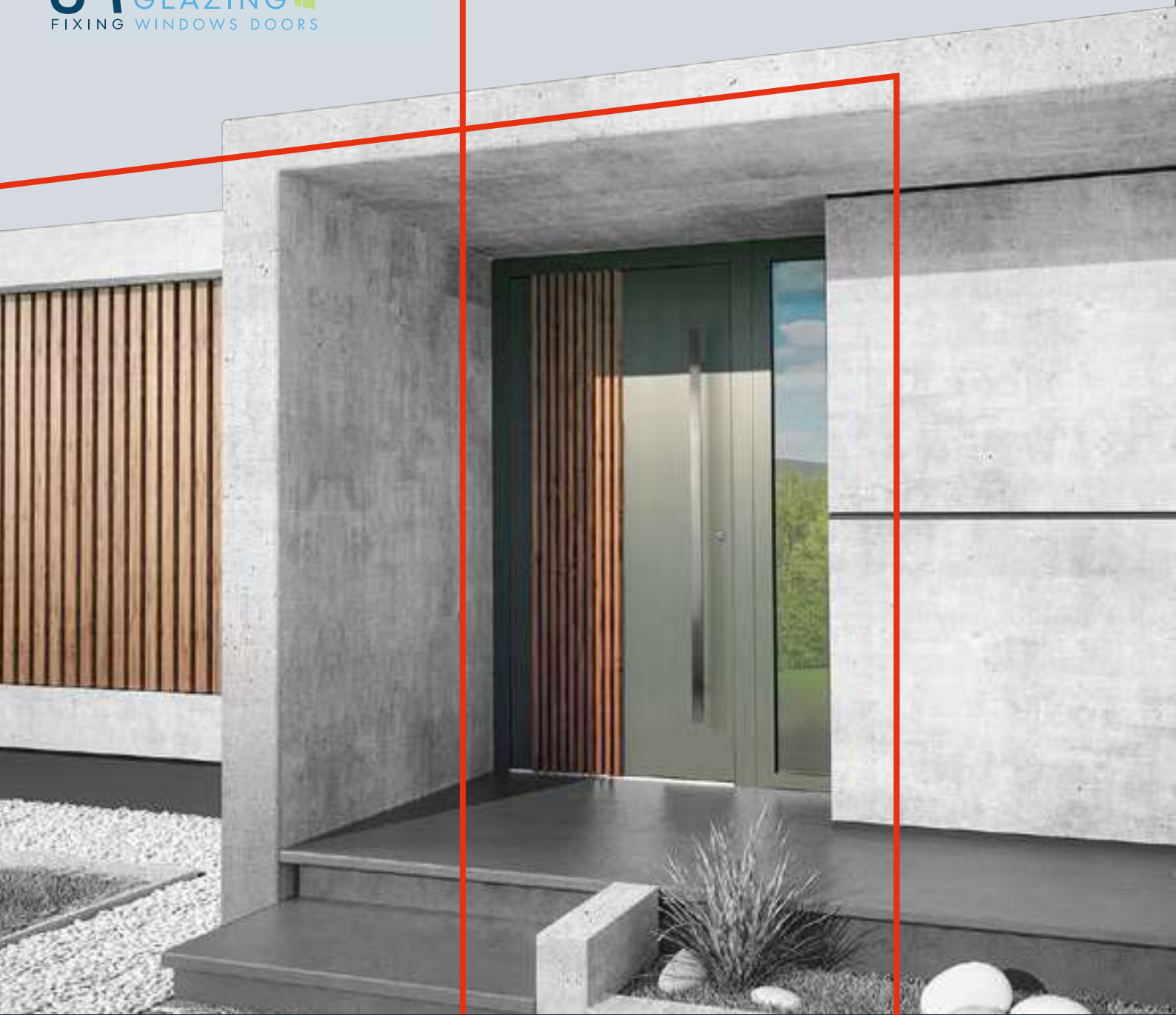

DOOR INFILL PANEL CATALOGUE

TABLE OF CONTENTS

News	11
Series NATURAL	
STONE LINE	12
CONCRETE LINE	15
CERAMICS LINE	16
Series ALUMINIUM	
LINEO LINE	19
GLASS LINE	21
INTEGRO LINE	23
NEW BLACK DESIGN	26
PREMIUM LINE	28
RETRO LINE	39
ACCESSORIES	41

OPEN TO INNOVATION



DOOR INFILL PANELS
ARE NOT JUST ABOUT DOOR DESIGN,
THEY'RE ALSO A CALLING CARD
OF YOUR HOME.

Highest quality can only be achieved by using the latest technology. Dinddecor manufactures door infill panels based on advanced technological solutions. Our modern equipment resources, featuring CNC machine tools, a line for the production of insulated glass and for performing decorative coatings by sublimation on aluminium profiles and sheets, and a modern powder paint shop allow us to achieve the highest quality of our products.

Dinddecor designs and manufactures high-quality door fillings that match your vision and needs. Every day we try to meet the expectations of our business partners - manufacturers of joinery and aluminium systems, therefore we manufacture our products according to the customer's ideas and with attention to details.

NEW PRODUCTS 2022

Our range of door infill panels is presented in two series: Natural and Aluminium. The Natural series includes door models in the Stone Line, Concrete Line and the new Ceramics Line. The Aluminium series has been expanded with new models in new designs and materials in the Lineo Line, Glass Line, Integro Line, New Black Design with Premium Line and Retro Line.



NEW BLACK DESIGN

Inspired by exclusive New Black Design. In select Premium Line models, we replaced the stainless steel colour and accessories with black colour and accessories. When designing the new doors to emphasise the deep black applications, for contrast we used them in a composition with Woodec veneer available in four colours: Malt, Toffee, Alpine and Concrete. See at 32.



HANDLES PZV, PZL

PZV and PZL are decorative pull handles with a modern design, made of aluminium with the possibility of matching colour and dimensions to the infill panel. The PZV pull handle was designed at the height of the infill panel in the shape of a vertical 3D profile with a comfortable handle in the middle. The second PZL pull handle, thanks to its design with a combination of wide profiles, can be assembled in the shape of a bracket. See at 46, 66.



CERAMICS LINE

STOLARCHI
nagroda architektów 2022

We have new Ceramics Line door infill panels available in three select steel colours: Corten, Concrete, Grey. In this collection we used quartz sinter material produced from natural resources resistant to scratches and easy to care for. See at 12.

LINEO LINE

Recipient of the IRBS 2022 - Innovative Solutions of the Joinery Industry award - the new Lineo Line of door infill panels with vertical 3D aluminium fins. These designs are inspired by the decorative fins used on the façades of modern homes that reference the rhythm of tree trunks. See at 18.

IRBS
INNOWACYJNE
ROZWIĄZANIA
BRANŻY STOLARKI
2022



INTEGRO LINE

Integro Line door infill panels have been extended by models with a new recessed handle PWZ 2022. This handle is integrated with the door infill thanks to its construction, properly profiled and recessed into the aluminium door panel. LED backlighting can be used in it. See at 30.

RETRO LINE

Retro Line is a line of door infill panels, which has been extended by new models with decorative designs. The new models are especially dedicated to classic façades or old tenement houses, made using retro aluminium designs with milled frames. These designs perfectly replicate the carvings found on classic wood doors. See at 60.





 Series

NATU- RAL

 STONE LINE
CONCRETE LINE
CERAMICS LINE



STONE LINE

Stone is an expression of the beauty and strength of nature. No other material reflects the perfection of nature as stone does. Its irregular structure, surprising shapes, and rich palette of colours allow you to create unique, inimitable designs on your door.



MODEL SL 01

Colour: natural stone MAKALU
Handle: PQ 40 x 20 mm L-1600 mm, painted with RAL 9005



MODEL SL 02

Colour: RAL 7016 / natural stone MAKALU
Decorative applications: 3D stainless steel
Handle: PQ 40 x 20 mm L-1600 mm



MAKALU



ANNAPURNA



EVEREST

Doors from the STONE LINE collection can be made in three available natural stone materials: MAKALU, ANNAPURNA AND EVEREST. The presented colours and texture of stone veneer may vary slightly from the finished product, due to the diversity and uniqueness of the natural material.



MODEL SL 03

Colour: RAL 7016 / natural stone MAKALU
Glazing: Satinovo
Decorative applications: 3D stainless steel
Handle: PS 10 L- 1400 mm



Natural Annapurna stone combined with 3D stainless steel applications.



MODEL SL 04

Colour: natural stone ANNAPURNA
Glazing: Sand-etched as shown in design
Decorative applications: Metal painted to any RAL colour
Handle: PQ 10 40 x 20 mm L- 600 mm



MODEL SL 05

Colour: RAL 7016 / natural stone ANNAPURNA
Decorative applications: 3D stainless steel
Handle: PQ 40 x 20 mm L-1600 mm painted with RAL 9005



MAKALU



ANNAPURNA



EVEREST

Doors from the STONE LINE collection can be made in three available natural stone materials: MAKALU, ANNAPURNA AND EVEREST. The presented colours and texture of stone veneer may vary slightly from the finished product, due to the diversity and uniqueness of the.



MODEL SL 06

Colour: RAL 7001 / natural stone EVEREST
Decorative applications: 3D stainless steel
Handle: PQ 40 x 20 mm L-600 mm



MODEL SL 07

Colour: natural stone EVEREST
Handle: PWZ L- 1600 mm, integrated with the panel, painted with RAL 9005

NEW PRODUCT 2022

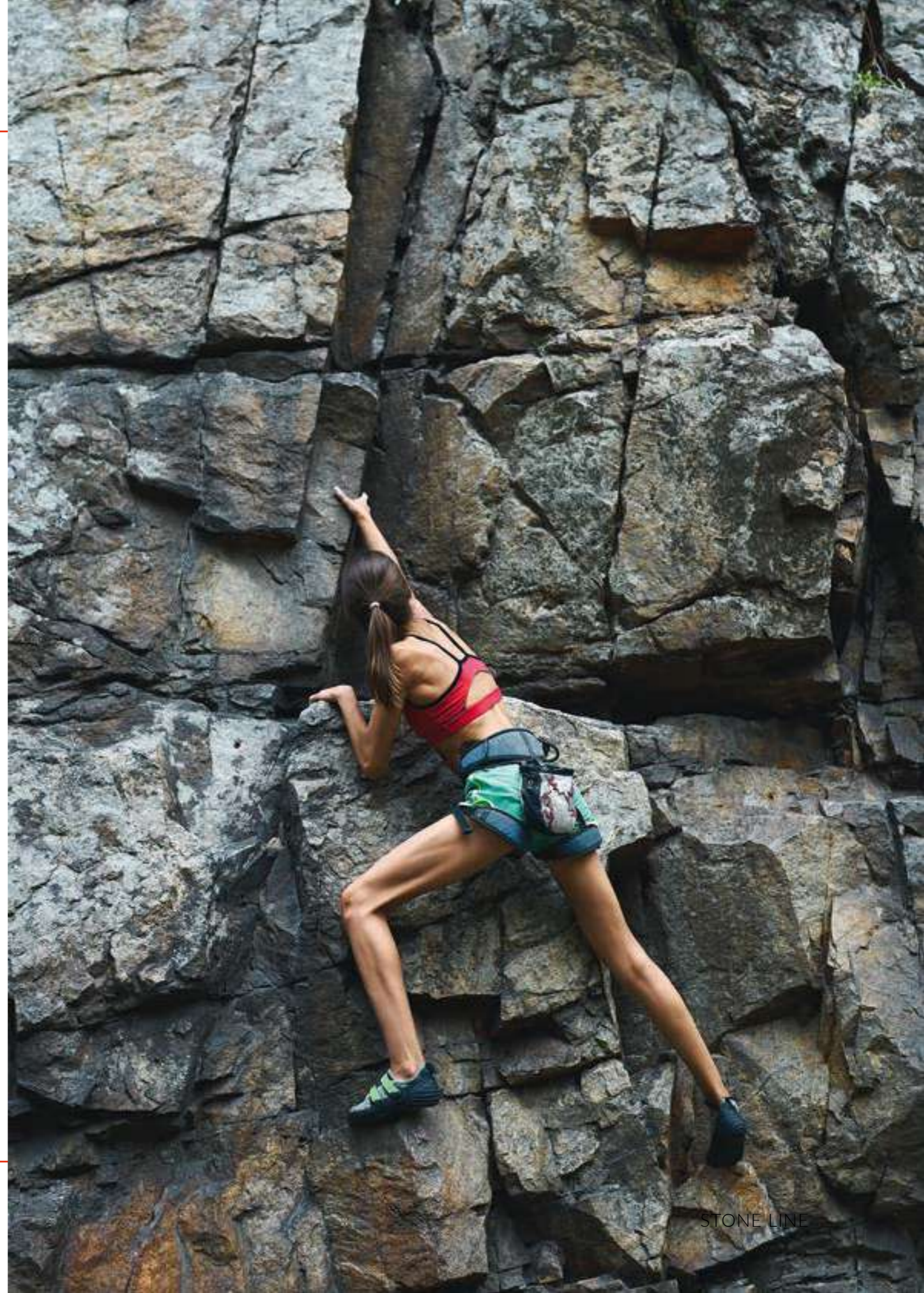

STONE LINE



CONCRETE LINE

Architectural concrete creates a modern and stylish look for your door. Concrete Line door infill panels are characteristic for their minimalism and timeless design, perfectly fitting into modern architecture.



MODEL BE 01

Colour: Architectural concrete
Handle: PQ 10 40 x 20 mm
L-1600 mm



MODEL BE 02

Colour: Architectural concrete
Glazing: Satinovo
Handle: PQ 10 40 x 20 mm
L-1600 mm ainted with
RAL 9005



MODEL BE 03

Colour: Architectural concrete
Decorative applications: 3D
stainless steel
Handle: PQ 10 40 x 20 mm
L-1600 mm



MODEL BE 04

Colour: Architectural concrete
Handle: PWZ L-1600 mm integrated
with the panel, painted with
RAL 9005

The presented colours and texture of architectural concrete may vary slightly from the finished product, due to the diversity and uniqueness of the natural material.



CERAMICS LINE

Sintered stone is a combination of beauty, safety, durability and longevity. This ceramic imitates natural materials like stone, wood or metal. Ceramics Line patterns are a source of inspiration for designers in modern and traditional architectural solutions.



NEW PRODUCTS 2022



MODEL SK 01

Material: Quartz sinter
Colour: Iron Corten Satin
Applications: 3D stainless steel
Handle: PW 22, stainless steel colour



MODEL SK 02

Material: Quartz sinter
Colour: Iron Corten Satin
Handle: PQ 10 40 x 20 mm, L-1600 mm painted with RAL 9005

CONCRETE

CORTEN

GREY

Doors from the CERAMICS LINE collection can be made in the available three colours of quartz sinter: CONCRETE, CORTEN AND GREY. The colours and texture of quartz sinter shown may vary slightly from the finished product due to the variety and uniqueness of the natural material.

STOLARCHI
nagrada architektów 2022

Ceramics Line door fillings won a distinction in the FORM category in the STOLARCHI 2022 competition

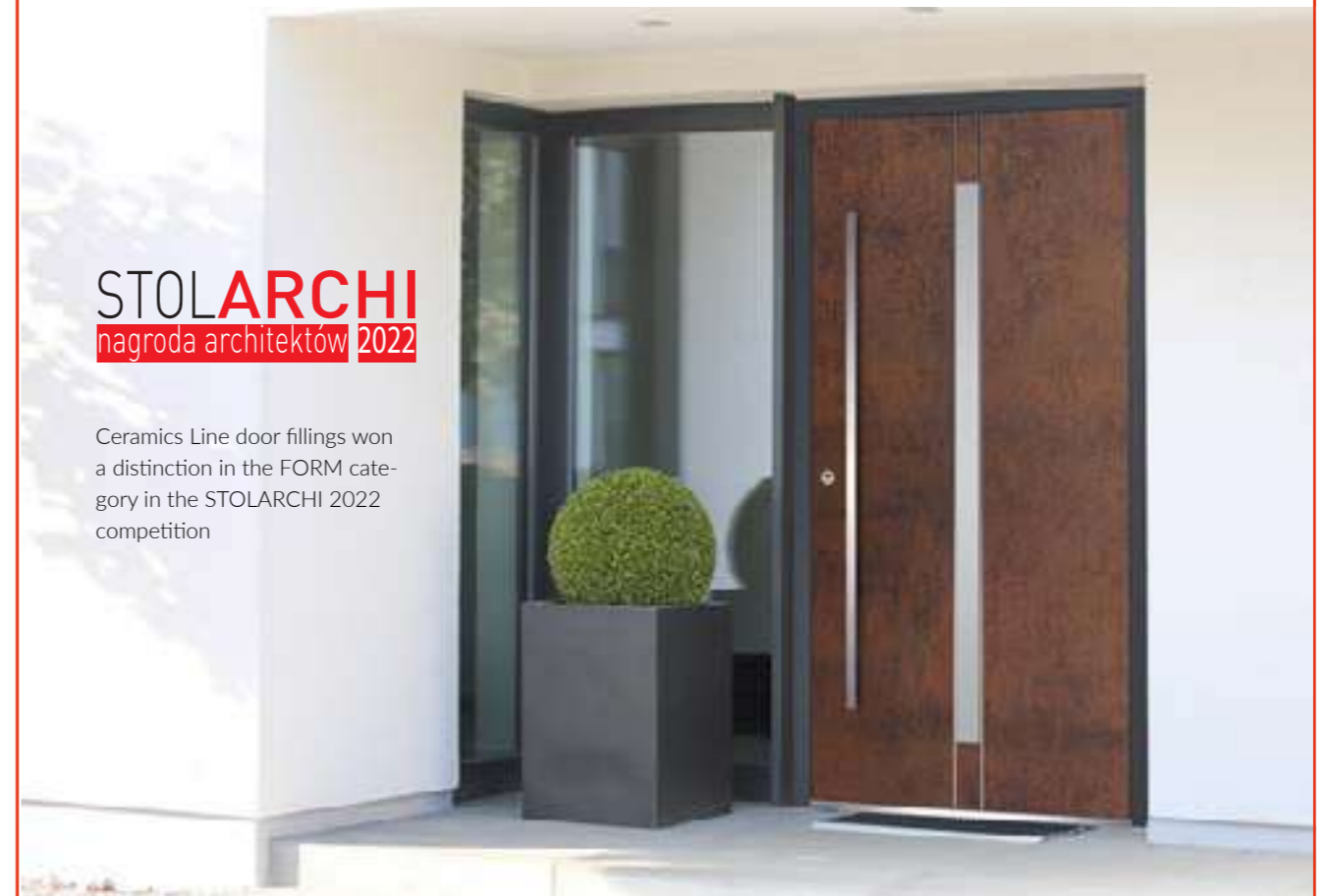



CONCRETE

CORTEN

GREY

NEW PRODUCTS 2022



MODEL SK 03

Material: Quartz sinter
 Colour: Concrete Silk
 Applications: 3D stainless steel
 Handle: PQ 10 40 x 20 mm,
 L-1400 mm



MODEL SK 04

Material: Quartz sinter
 Colour: Concrete Silk
 Glazing: Sand-etched
 as shown in design
 Applications: 3D stainless steel
 Handle: PQ 10 40 x 20 mm,
 L-1600 mm

NEW PRODUCTS 2022



MODEL SK 05

Material: Quartz sinter
 Colour: Iron Grey Satin
 Glazing: Satinovo
 Applications: 3D stainless steel
 Handle: PQ 10 40 x 20 mm,
 L-1400 mm



MODEL SK 06

Material: Quartz sinter
 Colour: Iron Grey Satin
 Handle: PWZ L-1600 mm integrated
 with the panel, painted with
 RAL 9005

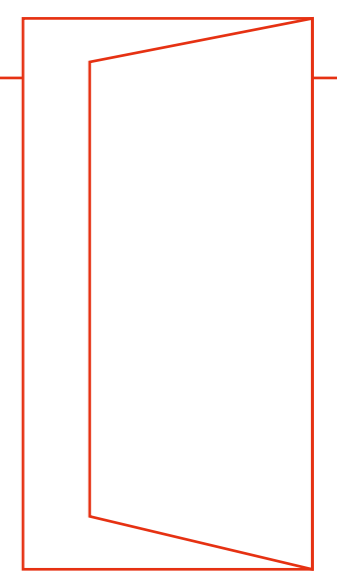

The doors in Ceramics Line open into the inside. The front side is made of quartz sinter and the inside door panel is made of aluminium.

Doors from the CERAMICS LINE collection can be made in the available three colours of quartz sinter: CONCRETE, CORTEN AND GREY. The colours and texture of quartz sinter shown may vary slightly from the finished product due to the variety and uniqueness of the natural material.





 Series

ALUMI- NIUM

 LINEO LINE
GLASS LINE
INTEGRO LINE
NEW BLACK DESIGN
PREMIUM LINE
RETRO LINE

LINEO LINE

In the LINEO LINE collection, the main motif is vertical 3D fins made of aluminium profiles on aluminium doors. Doors are inspired by the vertical fins used on the façades of modern homes that reference the rhythm of tree trunks.

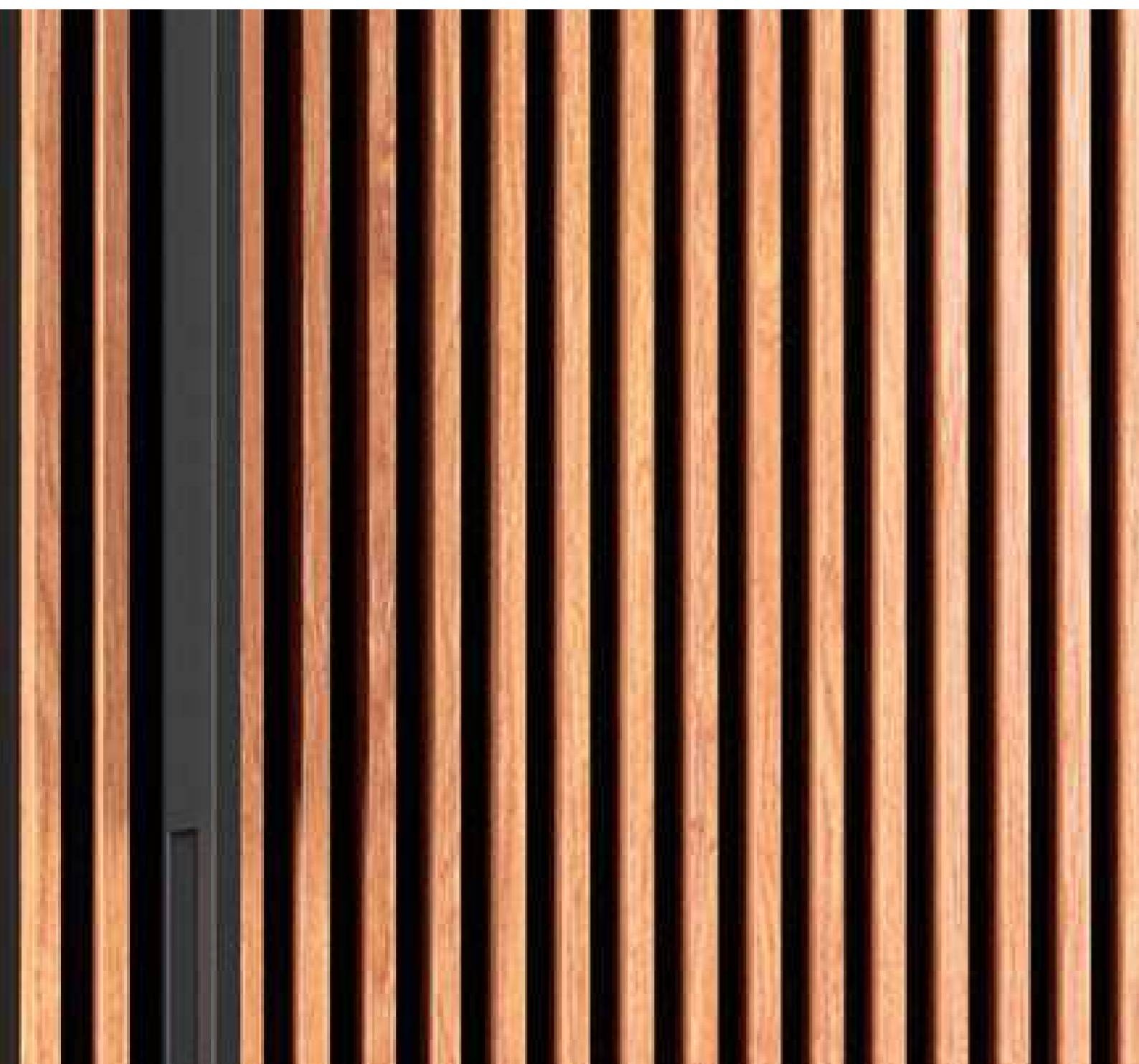

NEW PRODUCTS 2022



MODEL LL 01

Colour: RAL 9005 / dekorak Winchester
Applications: Vertical 3D fins in dekorak Winchester colour
Handle: PQ 10 40 x 20 mm L-1600 mm painted to RAL 9005



MODEL LL 02

Colour: Woodec Malt veneer
Applications: Vertical 3D fins in colour RAL 9005
Handle: PQ 10 40 x 20 mm L-1600 mm painted to RAL 9005



MODEL LL 02 WD

Colour: RAL 7021
Applications: Vertical 3D fins in dekorak Winchester colour
Handle: PQ 10 40 x 20 mm L- 1600 mm, stainless steel

LINEO LINE doors distinguished and awarded in IRBS 2022 program.



The presented doors from the Lineo Line can be made in any RAL colour. The colours shown may vary slightly from the finished product.



MODEL LL 03 WD

Colour: RAL 9005
 Applications: Vertical 3D fins in dekoral Winchester colour
 Handle: PZV matching the door panel height, in RAL 9005



MODEL LL 03

Colour: Woodec Malt veneer
 Applications: Vertical 3D fins in colour RAL 9005
 Handle: PZV matching the door panel height, in RAL 9005



Handle PZV matching the door panel height, in RAL 9005



MODEL LL 04

Colour: RAL 9005
 Glazing: Satinovo
 Applications: Black glass / Vertical 3D fins in dekoral Winchester colour
 Handle: PQ 10 40 x 20 mm L-1200 mm, stainless steel



MODEL LL 05

Colour: RAL 9005
 Applications: Vertical 3D fins in dekoral Winchester colour
 Handle: PQ 10 40 x 20 mm L-1400 mm, stainless steel



MODEL LL 06

Colour: RAL 7016
 Applications: Vertical 3D fins in dekoral Winchester colour
 Handle: PWZ L-1600 mm, integrated with panel in RAL 7016 colour

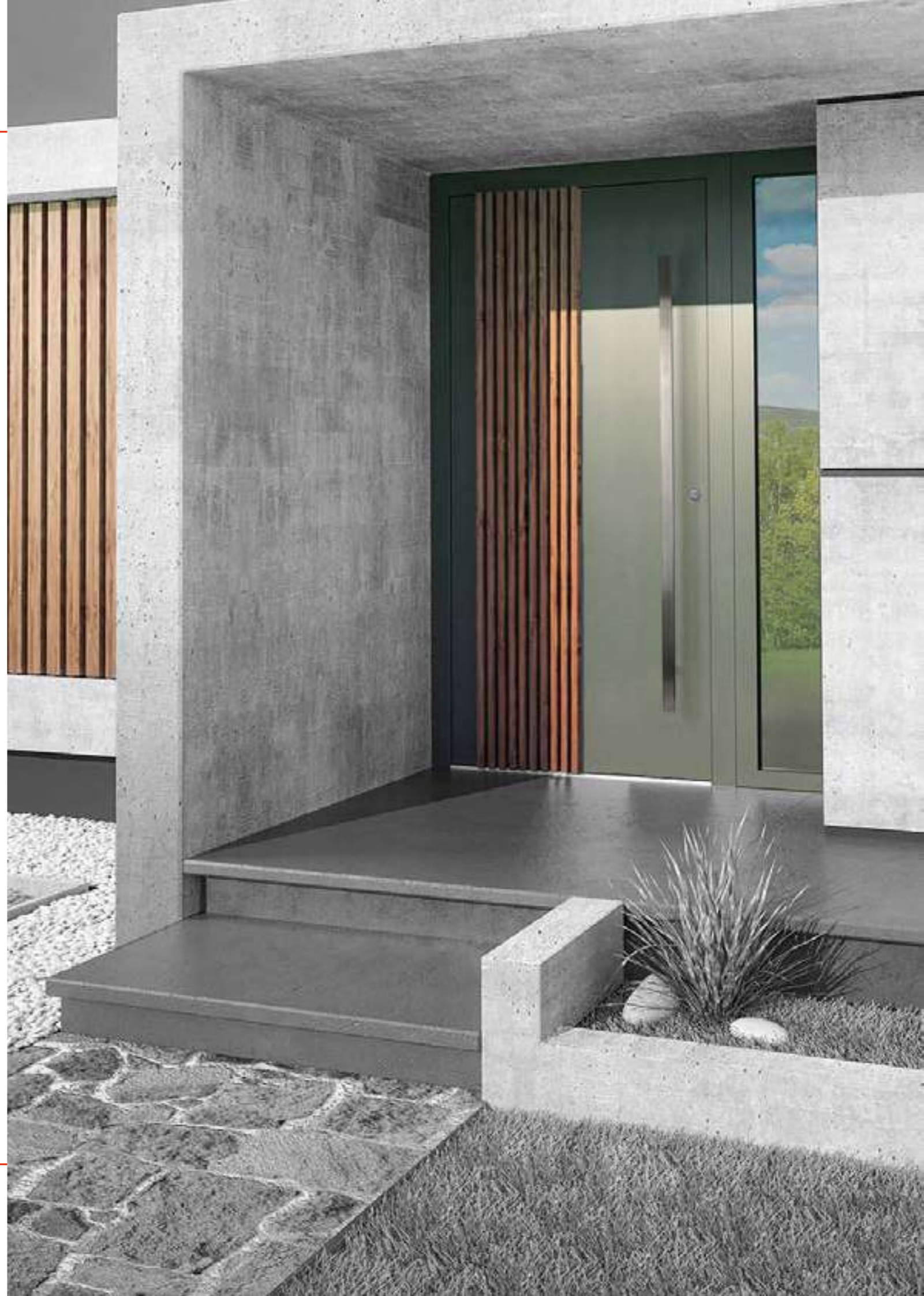

GLASS LINE

Glass Line is a door infill panel with an elegant black 3D glass application. Black lacquered glass has many advantages; it is not only aesthetically pleasing but also practical to keep clean and resistant to adverse external factors.



MODEL GL 01

Colour: RAL 9016
Glazing: Satinovo
Decorative applications: Black glass
Handle: PQ10 40 x 20 mm L-1600 mm painted with RAL 9005



MODEL GL 02

Colour: RAL 7016
Glazing: Sand-etched as shown in design
Decorative applications: Black glass, Routing
Handle: PS 10 L-1600 mm



MODEL GL 03

Colour: RAL 9016
Glazing: Satinovo
Decorative applications: Black glass, 3D stainless steel
Handle: PS 10 L-1600 mm



The presented doors from the Glass Line can be made in any RAL colour. The colours shown may vary slightly from the finished product.

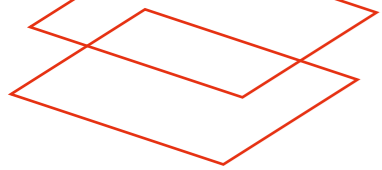

Flush or 3D stainless steel applications



MODEL GL 04

Colour: RAL 7001
Decorative applications:
Black glass, Routing
Handle: PS 10 L-1200 mm



MODEL GL 05

Colour: RAL 7016 / Woodec veneer
Glazing: Satinovo
Decorative applications:
Black glass, Routing
Handle: PS 10 L-1400 mm
painted with RAL 9005



MODEL GL 06

Colour: Montana veneer
Glazing: Sand-etched as shown
in design
Decorative applications: Black glass
Handle: PQ 10 40 x 20 mm
L-1200 mm

NEW PRODUCTS 2022



MODEL GL 07

Colour: RAL 7016
Decorative applications: Black glass,
stainless steel
Handle: PQ 10 40 x 20 mm
L-1400 mm, stainless steel



MODEL GL 08

Kolor: Black glass
Handle: PS 10 CD L-1600 mm
stainless steel



INTEGRO LINE

Integro Line door infill panels are distinguished by their simplicity and at the same time focus on the essential product element - the integrated recessed handle. They please the eye with their aesthetics, and thanks to the possibility of using LED strips they beautifully illuminate the entrance to your home.

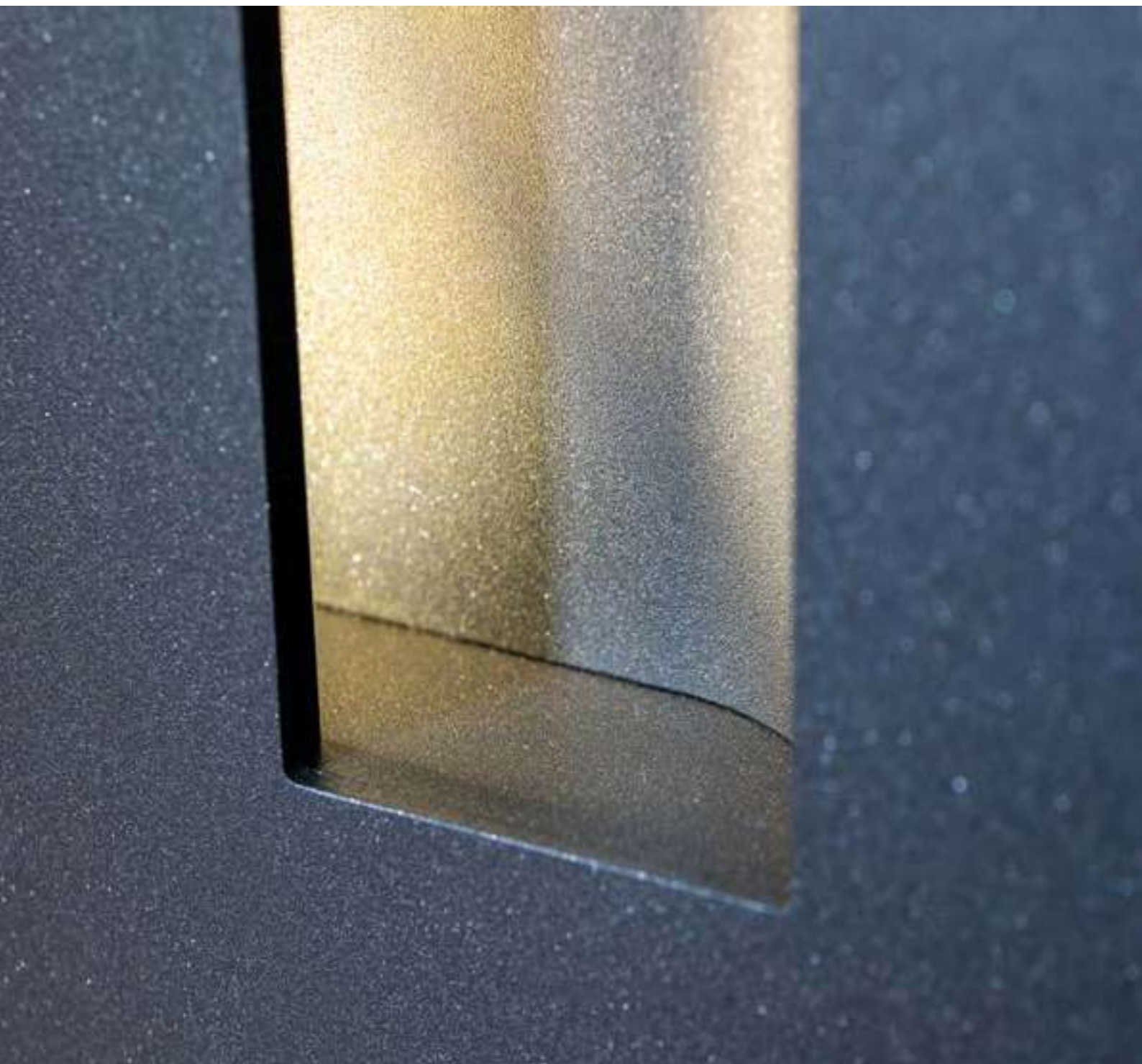

MODEL 6115 PW

Colour: RAL 9007
Handle: PWZ L-1600 mm, integrated with the panel, painted to match infill panel colour



MODEL 6116 PW

Colour: RAL 9016
Glazing: Satinovo
Handle: PWZ L-1600 mm, integrated with the panel, painted to match infill panel colour



MODEL 6117 PW

Colour: RAL 7016
Decorative applications: Routing
Handle: PWZ L-1600 mm, integrated with the panel, painted to match infill panel colour



Handle PWZ recessed and integrated into the infill panel, lacquered in the infill panel colour, with possibility of LED illumination.

The presented doors from the Integro Line can be made in any RAL colour. The colours shown may vary slightly from the finished product.



MODEL 6118 PW

Colour: RAL 7004
Handle: PW 23, L-1400 mm
stainless steel



MODEL 6120 PW

Colour: RAL 9016
Decorative applications:
Stainless steel, flush with surface
Handle: PW L-1000 mm, integrated
with the panel, painted to match
infill panel colour



MODEL 6121 PW

Colour: RAL 9006
Decorative applications: Montana
veneer
Handle: PW L-1000 mm, integrated
with the panel, painted to match
infill panel colour

STAINLESS STEEL

VENEER

RAL 9005



MODEL 6119 PW

Colour: RAL 7016
Decorative applications:
Stainless steel, flush with surface
Handle: PW L-1600 mm, integrated
with the panel, painted to match
infill panel colour



MODEL 6124 PW

Colour: Decoral® Winchester
Decorative applications:
Flush, painted RAL 9005,
Handle: PW L-800 mm, integrated
with the panel, painted to match
infill panel colour

Decorative applications

Decoral® Winchester
heat-transfer film





MODEL 6125 PW

Colour: DB 703
Decorative applications: Routing
Handle: PWZ 2022 L-700 mm,
integrated with the panel, painted
to match infill panel colour



MODEL 6126 PW

Colour: RAL 7016
Decorative applications: Routing
Handle: PWZ 2022 L-1300 mm,
integrated with the panel, painted
to match infill panel colour



MODEL 6127 PW

Colour: DB 703 / RAL 7016
Decorative applications: Routing
Handle: PWZ 2022 L-1600 mm,
integrated with the panel, painted
to match infill panel colour



Handle PWZ 2022 recessed
and integrated into the infill pa-
nel, lacquered in the infill panel
colour, with possibility of LED
illumination.



NEW BLACK DESIGN

Inspired by exclusive New Black Design. In select Premium Line models, we replaced the stainless steel colour and accessories with black colour and accessories. When designing the new doors to emphasise the deep black applications, we used them in a composition with Woodec veneer available in four colours: Malt, Toffee, Alpine and Concrete.

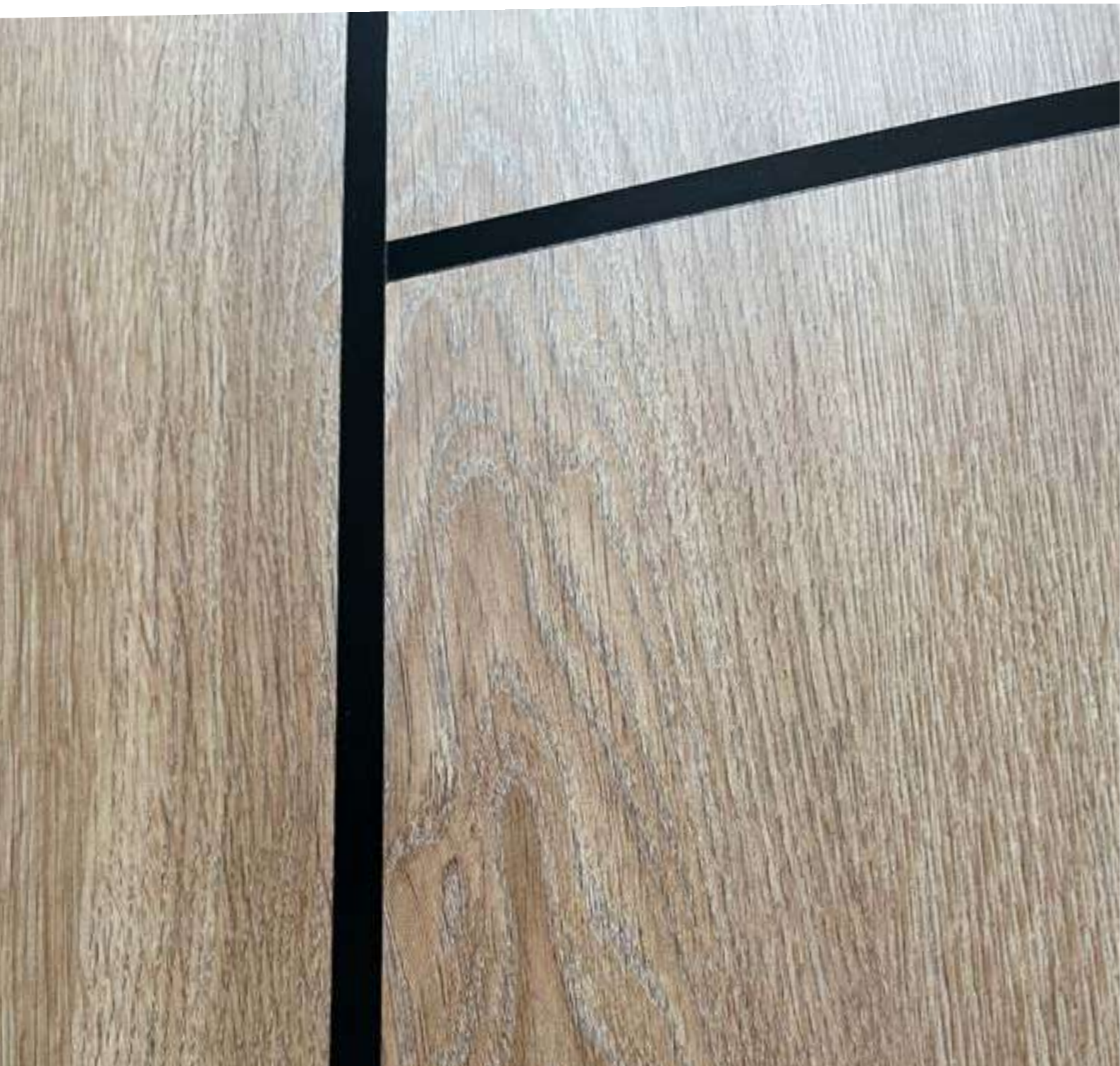

NEW PRODUCTS 2022

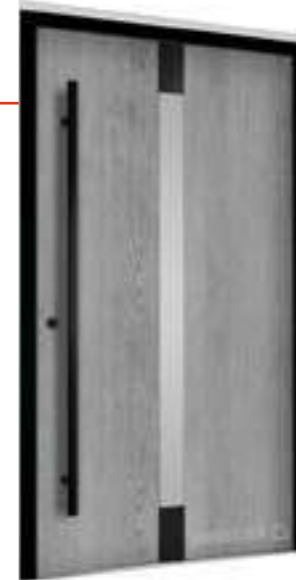

MODEL 1301 BLACK

Colour: Woodec Concrete veneer
Glazing: Satinovo
Applications: Black
Handle: PQ 10 40 × 20 mm
L-1600 mm in RAL 9005



MODEL 1401 BLACK

Colour: Woodec Toffee veneer
Glazing: Satinovo
Applications: Black
Handle: PQ 10 40 × 20 mm
L-1600 mm in RAL 9005



MODEL 2801 BLACK

Colour: Woodec Malt veneer
Applications: Black
Handle: PQ 10 40 × 20 mm
L-1600 mm in RAL 9005



MODEL 2802 BLACK

Colour: Woodec Malt veneer
Glazing: Sand-etched as shown in design
Applications: Black
Handle: PQ 10 40 × 20 mm
L-1600 mm in RAL 9005



MODEL 5007 BLACK

Colour: Woodec Concrete veneer
Glazing: Satinovo
Applications: Black
Handle: PQ 10 40 × 20 mm
L-1600 mm in RAL 9005



MODEL 5009 BLACK

Colour: Woodec Alpine veneer
Applications: Black
Handle: PQ 10 40 × 20 mm
L-1400 mm in RAL 9005

The presented doors from the New Black Design can be made in any RAL colour. The colours shown may vary slightly from the finished product.



MODEL 5015 BLACK

Colour: Woodec Malt veneer
Handle: PZL matching the door panel height, in RAL 9005



MODEL 5018 BLACK

Colour: Woodec Malt veneer
Applications: Black
Handle: PW 10 in RAL 9005



MODEL 5026 BLACK

Colour: Woodec Alpine veneer
Glazing: Satinovo
Applications: Black
Handle: PQ 10 40 x 20 mm
L-1400 mm in RAL 9005



MODEL 6002 BLACK

Colour: Woodec Malt veneer
Glazing: Satinovo
Applications: Black
Handle: PQ 10 40 x 20 mm
L-1200 mm in RAL 9005



MODEL 6102 BLACK

Colour: Woodec Toffee veneer
Glazing: Satinovo
Applications: Black
Handle: PQ 10 40 x 20 mm
L-1200 mm in RAL 9005



MODEL 6132 BLACK

Colour: RAL 9005 / Woodec Malt veneer
Applications: Black
Handle: PQ 10 40 x 20 mm
L-1200 mm in RAL 9005



In the New Black Design door collection, showcasing the black application, we used the new Woodec veneers on the door infill panels in: Malt, Toffee, Alpine i Concrete.



ALPINE



MALT



CONCRETE



TOFFEE

PREMIUM LINE

Door infill panels from the Premium Line are characterised by their modern and prestigious design. Geometric and finely crafted applications in flush or 3D stainless steel bring them to life. For those who appreciate minimalism, we present toned patterns broken with millwork or glazing.



MODEL 2802 FR

Colour: RAL 7016
 Glazing: Sand-etched as shown in design
 Decorative applications: Routing
 Handle: PD 134 L-1600 mm, Oak wood



MODEL 2802

Colour: RAL 7016
 Glazing: Sand-etched as shown in design
 Decorative applications: Stainless steel, flush with surface
 Handle: PD 134 L-1600mm, Oak wood



Handle PD 134, Oak wood



MODEL 2802 BS

Colour: RAL 7004 / metal painted to any RAL colour
 Glazing: Sand-etched as shown in design
 Decorative applications: Stainless steel, flush with surface
 Handle: Pochwył: PS 10 L-1600 mm



MODEL 2802 WD

Colour: RAL 7016 / Decoral Golden Oak
 Glazing: Sand-etched as shown in design
 Decorative applications: Stainless steel, flush with surface
 Handle: PS 10, L-1600 mm

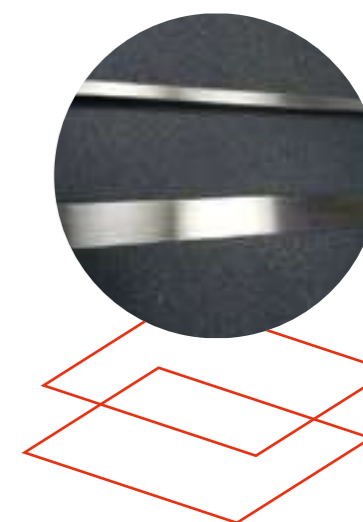

Flush or 3D stainless steel applications



The presented doors from the Premium Line can be made in any RAL colour. The colours shown may vary slightly from the finished product.



MODEL 1101

Colour: RAL 7016
Glazing: Satinovo
Handle: PS 10 L-1600 mm



MODEL 1301

Colour: RAL 7016
Glazing: Satinovo
Decorative applications:
Stainless steel, flush with surface
Handle: PS 10 L-1600 mm



MODEL 1401

Colour: RAL 7016
Glazing: Satinovo
Decorative applications:
Stainless steel, flush with surface
Handle: PS 10 L-1600 mm



MODEL 5026

Colour: RAL 7016
Glazing: Satinovo
Decorative applications:
Stainless steel, flush with surface
Handle: PS 10 L-1400 mm



MODEL 5026 WD

Colour: RAL 9016 / Decoral Golden Oak
Glazing: Satinovo
Decorative applications:
Stainless steel, flush with surface
Handle: PS 10 L-1400 mm



MODEL 5026 BS

Colour: RAL 7016 / metal painted to any RAL colour
Glazing: Satinovo
Decorative applications:
Stainless steel, flush with surface
Handle: PS 10 L-1400 mm



MODEL 5019

Colour: RAL 7001
Glazing: Sand-etched as shown in design
Handle: PS 10 - 800 mm



MODEL 5022

Colour: RAL 7016
Glazing: Satinovo
Handle: PS 10 L-1200 mm



MODEL 6002

Colour: RAL 9016
Glazing: Satinovo
Decorative applications:
Stainless steel, flush with surface
Handle: PS 10 L-1200 mm





MODEL 5009

Colour: RAL 7016
 Decorative applications: Routing
 Handle: PS 10 L-1200 mm



MODEL 5009 ST

Colour: RAL 7016
 Decorative applications: Stainless steel, flush with surface
 Handle: PS 10 L-1200 mm



MODEL 5018

Colour: RAL 7016
 Decorative applications: Stainless steel, flush with surface
 Handle: PW 10



MODEL 6111

Colour: RAL 9016
 Decorative applications: Routing
 Handle: PQ 10 L-800 mm painted with RAL 9005



MODEL 5014

Colour: RAL 7004
 Decorative applications: Routing
 Handle: PW 22

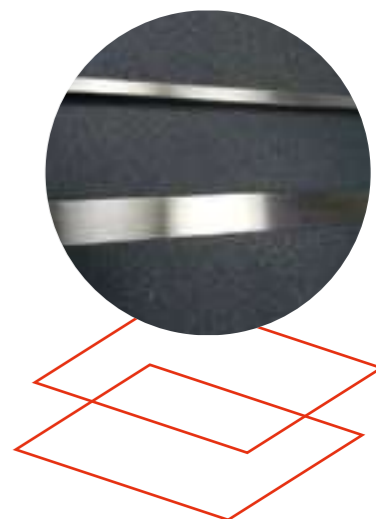

Flush or 3D stainless steel applications



MODEL 5007 ST

Colour: RAL 7016
 Glazing: Satinovo
 Decorative applications:
 Stainless steel, flush with surface
 Handle: PS 10 L-1400 mm



MODEL 5007

Colour: RAL 7016
 Glazing: Satinovo
 Decorative applications: Routing
 Handle: PS 10 L-1400 mm



MODEL 2901

Colour: RAL 7016
 Glazing: Satinovo
 Decorative applications: Routing
 Handle: PS L-800 mm



MODEL 5008

Colour: RAL 7016
 Glazing: Satinovo
 Decorative applications:
 Stainless steel, flush with surface
 Handle: PS 10 L-1200 mm



MODEL 5008

Colour: RAL 9007
 Glazing: Satinovo
 Decorative applications:
 Flush with Montana veneer
 Handle: PS 10 L-1200 mm



Montana veneer



MODEL 5031 ST

Colour: RAL 7021
 Glazing: Satinovo
 Decorative applications:
 Stainless steel, flush with surface
 Handle: PS 10 L-1200 mm



MODEL 5031

Colour: RAL 7016
 Glazing: Satinovo
 Decorative applications: Routing
 Handle: PD1 36 L-1200 mm,
 Jatoba wood



Handle PD1 36, Jatoba wood



MODEL 2801

Colour: RAL 7016
Decorative applications: Routing
Handle: PD 134 L-1600 mm,
Jatoba wood



MODEL 2801 ST

Colour: RAL 7016
Decorative applications:
Stainless steel, flush with surface
Handle: PQ 10 40 x 20 mm
L-1600 mm



MODEL 2801 BS

Colour: RAL 9016 / metal painted
to any RAL colour
Decorative applications:
Stainless steel, flush with surface
Handle: PQ 10 40 x 20 mm
L-1600 mm



MODEL 5004

Colour: RAL 7016
Decorative applications: Stainless
steel, flush with surface, Routing
Handle: PS 10 L-1200 mm



MODEL 5004

Colour: RAL 7016
Decorative applications: Flush
with Montana veneer, Routing
Handle: PS 10 L-1200 mm



MODEL 5015

Colour: RAL 3005
Handle: PS10 L-1800 mm



MODEL 5017

Colour: RAL 3003
Decorative applications: Routing
Handle: PW 25



MODEL 5011

Colour: RAL 7001
Decorative applications: Routing
Handle: PW 104



Handle PW 104



MODEL 6130

Colour: RAL 7001
Decorative applications: Routing
Handle: PQ 10 40 x 20 mm
L- 800 mm



MODEL 6131

Colour: RAL 7001
Handle: PZV matching the door panel
height, in RAL 7001



PZV handrail can be made in
any RAL color and adapted to
the height of the door panel.



PZL handrail can be made in any
RAL color and adjusted to the
height of the door panel.



MODEL 6128

Colour: RAL 7021
Decorative applications: Routing
Handle: PZL matching the door panel
height, in RAL 9005



MODEL 6129

Colour: DB 703 / Woodec Malt
veneer
Decorative applications: Routing
Handle: PQ 10 40 x 20 mm
L-1600 mm in RAL 9005





MODEL 2201

Colour: RAL 7016
Glazing: Satinovo
Decorative applications:
Stainless steel, flush with surface
Handle: PS 20 L-850 mm



MODEL 5006

Colour: RAL 7016
Glazing: Satinovo
Decorative applications: Routing
Handle: PS 20 L-1000 mm



MODEL 5040

Colour: RAL 7016
Glazing: Satinovo
Decorative applications: Stain-
less steel,
flush with surface, Routing
Handle: PS 20 L-900 mm



MODEL 6103

Colour: RAL 9016
Glazing: Satinovo
Decorative applications: Stain-
less steel, flush with surface, Routing
Handle: PQ 40 x 20 mm L-1400 mm



MODEL 6010

Colour: RAL 9016
Glazing: Satinovo
Decorative applications:
Stainless steel, flush with surface
Handle: PS 10 L-800 mm



MODEL 6015

Colour: RAL 3004
Glazing: Satinovo
Handle: PS 10 L- 800 mm



MODEL 5001

Colour: RAL 9007
Decorative applications: Routing
Handle: PS 20 L-850 mm



MODEL 5032

Colour: RAL 7016
Glazing: Satinovo
Decorative applications: Routing
Handle: PS 10 L-1200 mm



MODEL 6008

Colour: RAL 9016
Glazing: Sand-etched
as shown in design
Decorative applications:
Stainless steel, flush with surface
Handle: PS 10 L-1200 mm



MODEL 1701

Colour: RAL 7016
Glazing: Satinovo
Decorative applications:
Stainless steel, flush with surface
Handle: PS 10 L-800 mm



MODEL 1702

Colour: RAL 7016
Glazing: Satinovo
Handle: PS 10 L-800 mm



MODEL 5038

Colour: RAL 7016
Glazing: Sand-etched as shown in design
Decorative applications:
Stainless steel, flush with surface
Handle: PS 10 L-1000 mm



MODEL 5046 FR

Colour: RAL 7004
Glazing: Satinovo
Decorative applications: Routing
Handle: PS 10 - 1000 mm



MODEL 5046

Colour: RAL 7016
Glazing: Satinovo
Decorative applications:
Stainless steel, flush with surface
Handle: PS 10 L-1000 mm



MODEL 6100

Colour: RAL 7016
Glazing: Sand-etched as shown in design
Decorative applications:
Stainless steel, flush with surface
Handle: PQ 40 x 20 mm L-1600 mm



MODEL 6101

Colour: RAL 7001
Glazing: Sand-etched as shown in design
Decorative applications: Stainless steel, flush with surface, Routing
Handle: PQ 40 x 20 mm L-1600 mm



MODEL 6102

Colour: RAL 7016
Glazing: Satinovo
Decorative applications:
Stainless steel, flush with surface
Handle: PS 10 L-1200 mm



MODEL 6102 FR

Colour: RAL 7016
Glazing: Satinovo
Decorative applications:
Routing
Handle: PS 10 L-1200 mm



Handle PZ 76, Stainless steel



MODEL 5010 BS

Colour: RAL 3004 / RAL 7016
 Glazing: Satinovo
 Decorative applications:
 Stainless steel, flush with surface
 Handle: PZ 76



MODEL 5010

Colour: RAL 7016
 Glazing: Sand-etched
 as shown in design
 Decorative applications:
 Stainless steel, flush with surface
 Handle: PS 20 L-1000 mm



Sandblasted glass with pattern with different types of mat, decorated with pasted Swarovski crystals.



MODEL 5041

Colour: RAL 9010
 Glazing: Sand-etched background, design formed from different types of matte, original Swarovski crystals embedded
 Handle: PZ 29



MODEL 5042

Colour: RAL 9007
 Glazing: Satin background, sand-etched as shown in design, coloured stick-on applications, glass decorative applications
 Handle: PS 10 L-1200 mm



MODEL 6104

Colour: RAL 7004 / RAL 9007
 Decorative applications: Routing
 Handle: PW 22



MODEL 6105

Colour: RAL 7004 / RAL 9016
 Glazing: Sand-etched
 as shown in design
 Decorative applications: Routing
 Handle: PQ 10 40 x 20 mm L-1200 mm



MODEL 6106

Colour: RAL 7004
 Glazing: Sand-etched
 as shown in design
 Handle: PQ 10 40 x 20 mm L-1600 mm



MODEL 5045

Colour: RAL 7016
 Glazing: Satinovo
 Decorative applications:
 Stainless steel, flush with surface
 Handle: PS 10 L-1000 mm





MODEL 6123

Colour: RAL 7016 / Decoral®
 Winchester heat-transfer film
 Decorative applications: Routing
 Handle: PQ 10 40 x 20 mm L-1600 mm
 ainted with RAL 9005



MODEL 6110

Colour: RAL 9007 / Montana veneer
 Glazing: Sand-etched as shown
 in design
 Handle: PS 10 L-1200 mm



MODEL 6122

Colour: RAL 7016
 Decorative applications: Flush
 with Woodec Malt veneer,
 Routing
 Handle: PQ 10 L-800 mm
 painted with RAL 9005



Montana veneer



MODEL 6107

Colour: RAL 7016 / Montana
 veneer
 Glazing: Sand-etched as shown in
 design
 Decorative applications: Routing
 Handle: PS 10 L-1000 mm



MODEL 6108

Colour: RAL 7016 / Golden Oak veneer
 Decorative applications: 3D
 stainless steel
 Handle: PQ 10 40 x 20 mm
 L-1600 mm

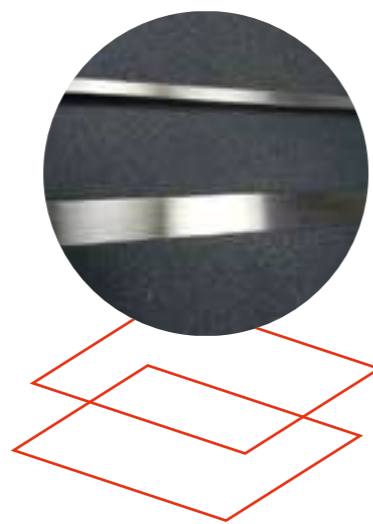

Flush or 3D stainless steel
 applications

NEW PRODUCT 2022



**MODEL
 PARZENICA**

Colour: Decoral®
 Winchester heat-transfer film
 Regional theme
 Handle: PQ 10 40 x 20 mm L-1600
 mm ainted with RAL 9005

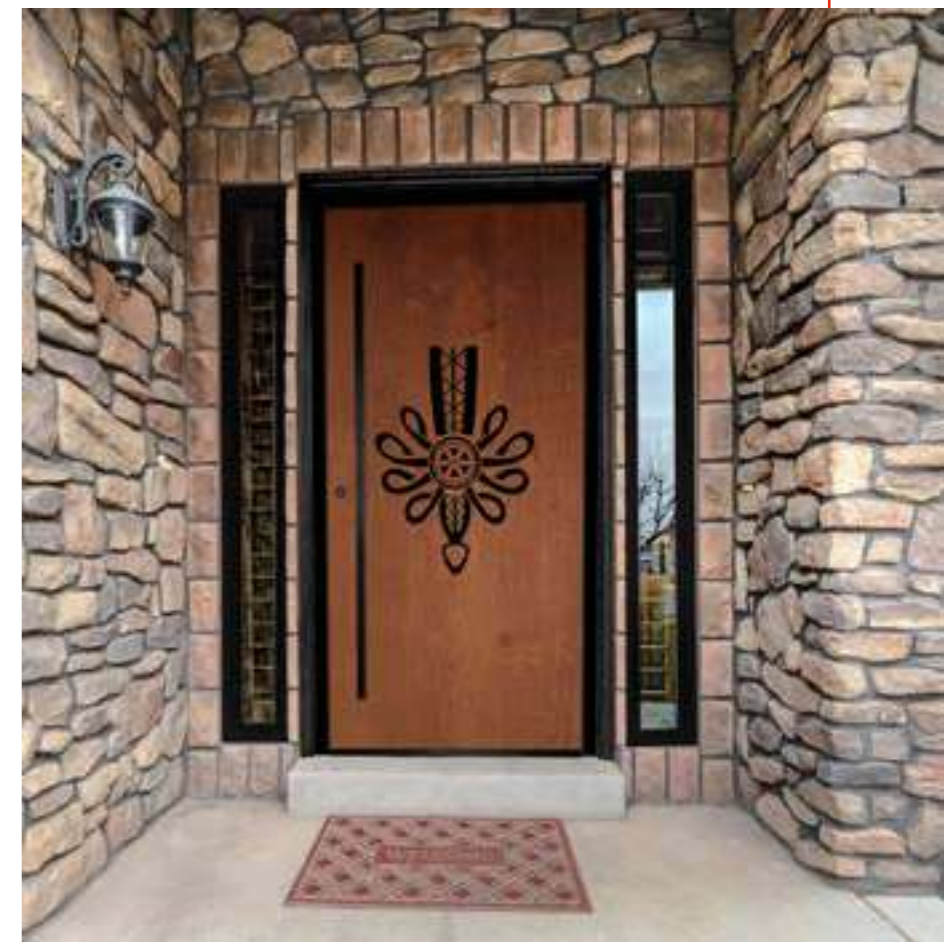



Routing



MODEL 6113 BS

Colour: RAL 9016 / Metal painted to any RAL colour
 Glazing: Sand-etched as shown in design
 Handle: PS 10 L-1200 mm



MODEL 6113 WD

Colour: RAL 9016 / Decoral Golden Oak
 Glazing: Sand-etched as shown in design
 Handle: PS 10 L-1200 mm



MODEL 6112

Colour: RAL 9016
 Glazing: Sand-etched as shown in design
 Decorative applications: Stainless steel, flush with surface, Routing
 Handle: PS 10 L-1200 mm



MODEL 6112 BS

Colour: RAL 9016 / Metal painted to any RAL colour
 Glazing: Sand-etched as shown in design
 Decorative applications: Routing
 Handle: PS 10 L-1200 mm



MODEL 6112 WD

Colour: RAL 9016 / Decoral Golden Oak
 Glazing: Sand-etched as shown in design
 Decorative applications: Routing
 Handle: PS 10D L-1200 mm



MODEL 6114

Colour: RAL 7035 / Metal painted to any RAL colour
 Glazing: Sand-etched as shown in design
 Decorative applications: Routing
 Handle: PS 10 L-1200 mm



MODEL 6109 BS

Colour: RAL 9016 / Metal painted to any RAL colour
 Glazing: Sand-etched as shown in design
 Decorative applications: Routing
 Handle: PS 10 L-1400 mm



MODEL 6109

Colour: RAL 9016 / Tiama veneer
 Glazing: Sand-etched as shown in design
 Decorative applications: Routing
 Handle: PS 10 L-1400 mm

RETRO LINE

The Retro Line means timeless designs with decorative details in classic style. Tradition and elegance are the qualities that will draw you into a tasteful interior. We present designs with classic frames and retro aluminium patterns.



MODEL RL 01

Colour: RAL 9016
Glazing: Satinovo
Decorative applications:
Classic style aluminium frames
Handle: PS 10 L-800 mm



MODEL RL 02

Colour: RAL 7016
Decorative applications:
Classic style aluminium frames
Handle: PS 10 L-800 mm



MODEL RL 03

Colour: RAL 7016
Decorative applications:
Classic style aluminium frames
Handle: PS 10 L-800 mm



The presented doors from the Retro Line can be made in any RAL colour. The colours shown may vary slightly from the finished product.



MODEL RL 04

Colour: RAL 7016
Glazing: Satinovo
Decorative applications:
Classic style aluminium frames
Handle: PS 10 L-800 mm



MODEL RL 05

Colour: RAL 9016
Glazing: Satinovo
Decorative applications:
Classic style aluminium frames
Handle: PS 10 L-800 mm

NEW PRODUCTS 2022



MODEL RL 06

Colour: RAL 7016
Glazing: Chinchilla
Applications: Aluminium retro pat-
terns with vintage style frame
Handle: PS 393417

NEW PRODUCTS 2022



MODEL RL 07

Colour: RAL 9016
Applications: Aluminium retro pat-
terns with vintage style frame
Handle: PS 393417



MODEL RL 08

Colour: RAL 9016
Applications: Aluminium retro patterns
with vintage style frame
Handle: PS 393417



MODEL RL 09

Colour: RAL 3004
Applications: Aluminium retro pat-
terns with vintage style frame
Handle: PS 393417



INFILL

Our products can be used in all types of aluminium and PVC doors available on the market.



STANDARD INSERT PANEL:

These panels are mounted in the door frame in the same way as typical doors. The profile of the door is visible both from the inside and the outside. This is the simplest and easiest to install type of door infill, offered in thicknesses of 24 and 36 mm as standard.



SINGLE-SIDED ATTACHMENT PANEL:

These panels are made from aluminium skin layers. On the outward facing layer, a 3 mm-thick aluminium sheet is attached to the door frame, making it invisible, while on the inward-facing side, beading is applied. This construction gives doors an elegant and cohesive look.



DOUBLE-SIDED ATTACHMENT PANEL:

These panels provide the highest heat insulation parameters. Aluminium sheets cover the doors from both sides, ensuring elegance and refined aesthetics. The total thickness of the infill is greatest in this type of construction and is adapted to the particular type of door profile.

GLASS

MASTER-CARRE
clear glass

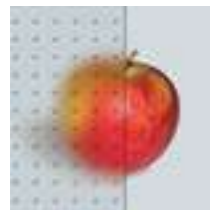

MASTER-POINT
clear glass



SATINOVO
milky glass



SAND-ETCHED
as shown



MASTER-LIGNE
clear glass



CHINCHILLA
clear glass



ANTISOL
grey glass



ANTISOL
brown glass



STOPSOL
grey glass



STOPSOL
brown glass



ONE-WAY GLASS
Mirrastar



TRANSPARENT
glass



ACCESORIES

HANDLES
ELECTRONICS
HANDLES
ROSETTES
PROTECTION
KICKS

SQUARE-PROFILE HANDLES

Available
in 40 x10, 40x20, 40x40mm

PQ 10

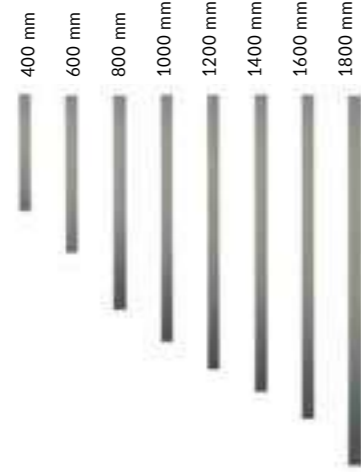

PQ 45

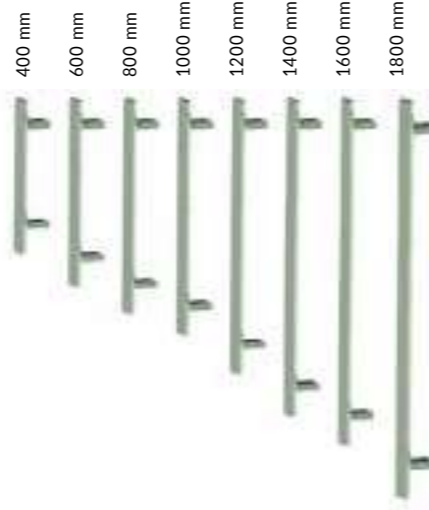

PS 10D



PS 45D



PS 10 CD

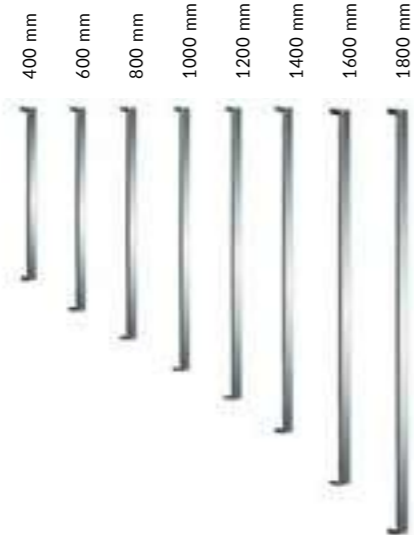

PQ WE 26 30 x 30 mm



STAINLESS STEEL

BLACK

BLACK ANODA

Other lengths
available
by request

STAINLESS STEEL

Other lengths
available
by request

STAINLESS STEEL

Other lengths
available
by request

ROUND-PROFILE HANDLES

PS 20



PS 10

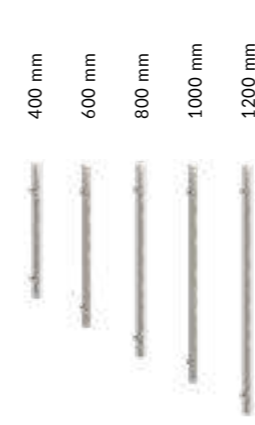

PS 45

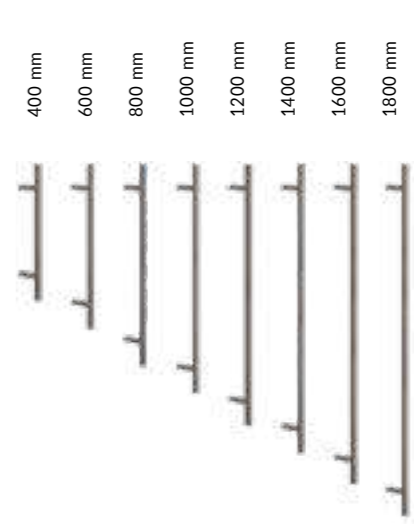

STAINLESS STEEL

Other lengths
available
by request

STAINLESS STEEL

BLACK

BLACK ANODA

INSET HANDLES

PW 10



PW 21



PW 22



PW 23



PW 72



available in the following lengths 1400mm

STAINLESS STEEL

BLACK

PW 10 with insert option



PW 19



PW 25



PW 72 with insert option



PW 104



STAINLESS STEEL

DECORATIVE HANDLES

STAINLESS STEEL

PZV



PZL



PS 393417



PS 379711



315 mm

QA



800 / 2000 / 2200 mm

QS

40 x 20 mm



1000 mm



PZ 29



PZ 31



PZ 44



PZ 45



PZ 76



PZ 83



PZ 77



PZ 82

HANDLES WITH WOODEN ELEMENTS



PD 124

available in 1000 and 1200 mm



PD 125

available in 1000 mm



PD 134

available in 1200 and 1600 mm



PD 136

available in 1000 and 1200 mm



PD 180

available in 800, 1000, 1200 and 1600 mm



PD 190

available in 800, 1000, 1200 and 1600 mm

All handles with wooden elements are available in four different varieties of wood: Oak, Jatoba, Walnut, Wenge

Handrails available in two variants, Jatoba wood and Walnut, with finishes in black and stainless steel

HANDLES WITH ELECTRONICS

E KEY PAPILLARY LINE READER



available in handle models: PS 10 and PS 45



available in handle models: PQ 10, PQ 45



IDENCOM PAPILLARY LINE READER



available in handle models: PQ 10 40x20, QS 40x20, PW 10, PW 72



available in handle models: PQ 10 40x40 and QA

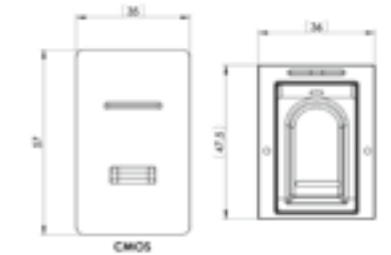

MICROSWITCH IN HANDLE



available in handle models: PS 10, PS 45, PD 134



available in handle models: PQ 10, PQ 45, QA, PW 10, PW 21, PW 22, PW 72

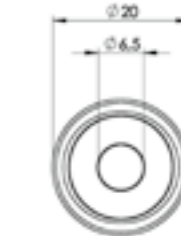

Available backlight colours:



TOUCH SENSOR IN THE HANDLE



available in handle models: PS 10, PS 45



available in handle models: PQ 10, PQ 45, QA, PW 10, PW 21, PW 22, PW 72

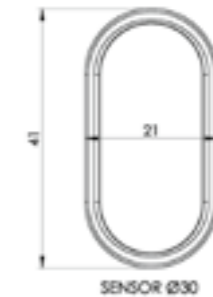

Available backlight colours:

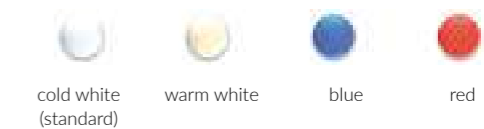

TOUCH SENSOR IN THE HANDLE

TOUCH SENSOR IN THE HANDLE



Available in handle models:

PS 10, PS 45, PQ 10, PQ 45, PW 10, PW 21, PW 22, PW 72, QS, QA

Available backlight colours:



cold white (standard) warm white blue red

PWZ HANDLE BACKLIGHTING



Available backlight colours:

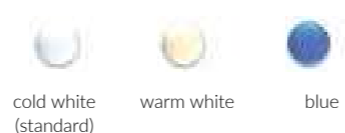

cold white (standard) warm white blue

HANDLES WITH DIGITAL MINI-CAMERA

Handrails with mini digital camera plus Internal color LCD display



PE 2284
30 x 20 x 1200 mm



PE 2294
H - 1200 mm

HANDLES



370900 silver **370902** white **370904** brown **370905** F9 **370907** gold **370909** stainless steel **H6S2 55S34** stainless steel, black **H6S26 SK3S34** stainless steel, black

ROSETTES



60421 **61421** **64421** **65421** **74421** **74422** **78421** **369846** **370969** **393882** **RS 20** **RS 10**

STAINLESS STEEL

SCRATCH PROTECTION



KS100 **KS200** **KS300** **KS400** **KS400 BIOKEY**

KICK PLATES END LETTERBOXES



Flush or surface mounted kick plate EK 100



Flush or surface mounted kick plate EK 200



372175



372180

Other designs available by request

TITAN makes versatility your

strength³

The innovative window hardware system
for timber and PVC.

Window systems

Door systems

Comfort systems

We bring spaces to life.



Our handle programmes TITAN GLOBE and Si-line: Designed to perfection.

Quality that is immediately tangible –

This distinguishes the TITAN GLOBE and Si-line handle ranges. This quality results from the ideal combination of aesthetics, ergonomics, functionality and material.

Furthermore, our handle line convinces with maximum functional safety and an optional choice of colours.

Benefits for users:

- Innovative, ergonomic design
- Easy and convenient handling
- Available in various colours for all the demands of modern architecture
- Ensures a continuous and optimal lock-in position
- Suitable for timber and PVC windows
- High degree of security against unwanted guests due to the Secustik and pressure key versions and the lockable handles
- TBT handle prevents unauthorised rotary opening (no turning position without key)
- Night vent with additional 45 lock-in position possible

TITAN GLOBE
STANDARD DESIGN

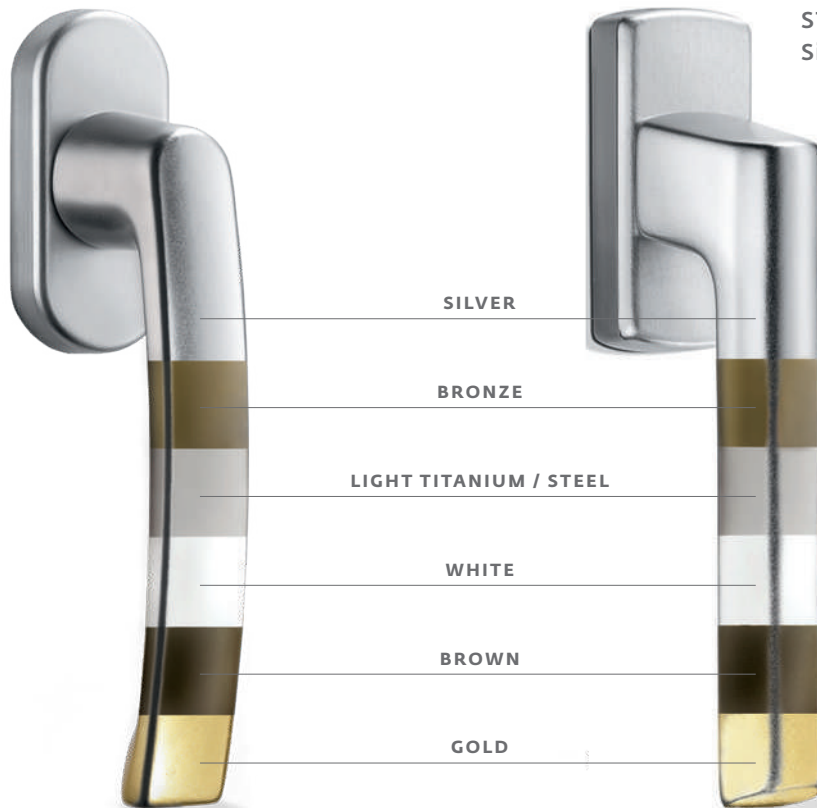

STANDARD DESIGN
Si-line

Overview TITAN GLOBE handle.

STANDARD

- Available in all colours
- With optional SIEGENIA logo

SECUSTIK*

- Automatically prevents hardware manipulation from outside
- Burglars can no longer force the window open

NIGHT VENT HANDLE*

- With 45° lock-in position
- Available as standard version

PUSHBUTTON HANDLE

- Automatically prevents hardware manipulation from outside
- Press button to unlock. When locking, the handle blocks automatically

40 Nm, LOCKABLE

- Affordable version for 100 Nm
- With pressure cylinder (push to close, key unlocking)
- With optional SIEGENIA logo

100 Nm, LOCKABLE

- With optional Secustik function
- With pressure cylinder (push to close, key unlocking)
- Tested in accordance with DIN EN 1627-1630

TBT HANDLE**

- Use with corresponding TBT (tilt before turn) hardware
- 40 Nm, lockable
- To reach the turning position, you must use the key separately (increased protection against unauthorised rotary opening)

REMOVABLE HANDLE WITH PUSH-ON ROSE

- Rose is securely mounted, can be pushed open; handle can be removed and reattached at any time (e.g. for cleaning)

FLAT HANDLE

- For locations where little space is available for the handle, e.g. with roller shutters
- Also for use with fold and slide hardware

TL/PZ AND TL/PZ FLAT

- For balcony and patio doors
- Includes handle inside and outside and PZ rose inside and outside
- TL/PZ flat for locations where the outside handle would be too high (e.g. with roller shutters or window shutters)



PRESSURE
KEY

LOCKABLE

REMOVABLE WITH
PUSH-ON ROSE

FLAT

TL/PZ

* Handle is visually the same as the standard version.

** Handle is visually the same as the lockable version.

PRODUCT CATALOGUE

ALUMINIUM WINDOWS AND DOORS



**SLIDE AND LIFT-SLIDE
SYSTEMS**

lift and slide door, angular solution 90° with floating mullion

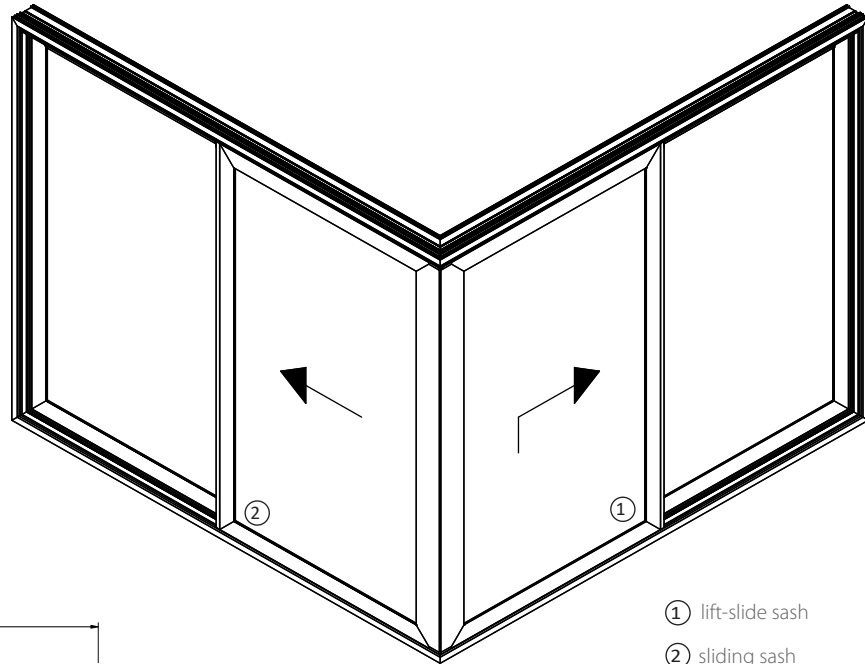

- ① lift-slide sash
- ② sliding sash

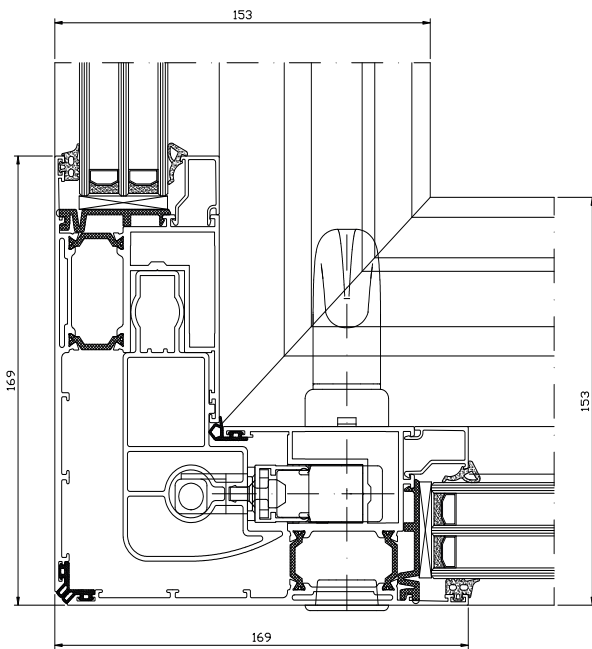

flat threshold UG114 (ULTRAGLIDE only)

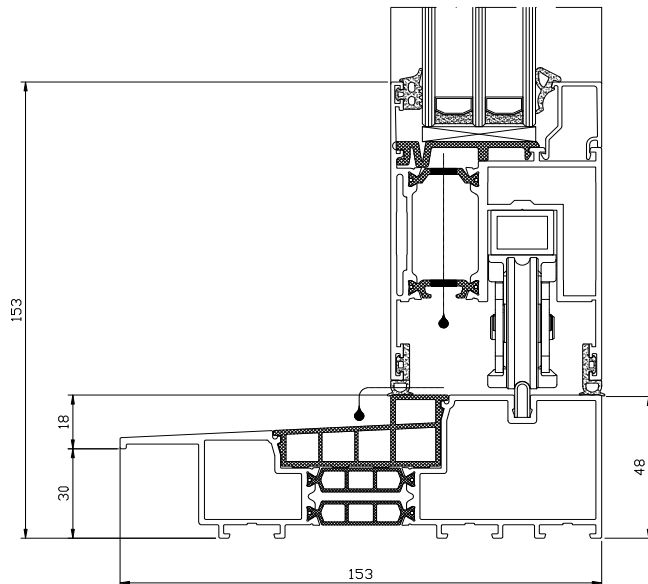

Flat threshold ULTRAGLIDE



OUR GALLERY



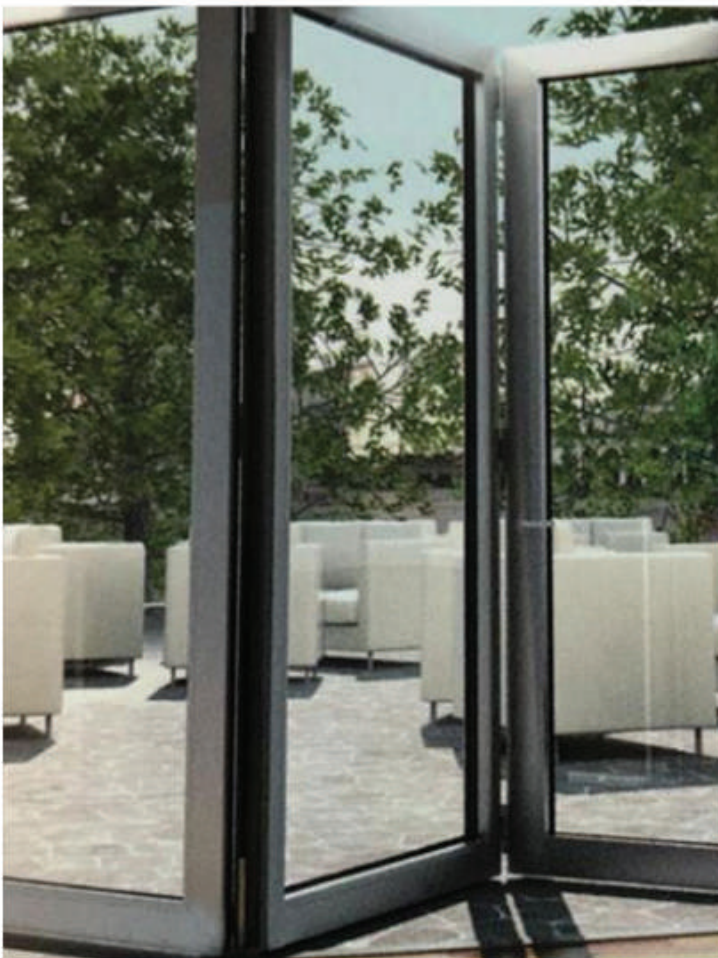



HOW TO REACH US



WWW.JRFIXING.IE



+353 879681592



JIMMY@JRFIXING.IE



RATHENISKA, STRADBALLY, CO LAOIS,
R32 VE86